

## An Open Gradient Magnetic Separator Assembled Using NdFeB Magnets for a Use of Fine Particles Remover

Eon Byung Park, Seung Duck Choi, Choong Jin Yang and Won Sub Lee<sup>1</sup>

*Electromagnetic Materials Lab., Research Institute of Industrial Science & Technology, P.O. Box 135, Pohang 790-600, Korea*

<sup>1</sup>*Div. of Technology Development, Pohang Iron & Steel Co., Ltd., P.O. Box 36, Pohang 790-785, Korea*

(Received 22 July 1998)

A drum type magnetic separator was designed and optimized by computer simulation. The separator consisted of rotating outer shell of drum, magnetic flux generator drum which was assembled with numbers of disk type magnet holders, and drum axis around which the magnet holders were fixed. NdFeB magnet blocks were inserted into the disks, and the disks were assembled layer by layer along the drum axis. Magnetic circuits of the separator were simulated on the basis of highest magnetic strength, least cost, and high yield of separation by using a Vector Field S/W employing the Opera-2D program. The separator proved a separation yield of 95% in removing fine iron-base particles, and installed at Hot Rolling Mill of Pohang Iron & Steel Co. in Korea.

### 1. Introduction

Various classification schemes exist in magnetic separation techniques. Although there are many classification schemes [1], their live and die can be best described according to (a) the way the magnetic field is generated, (b) how the magnetic particles are separated from the feed source, and (c) the magnitude of the magnetic field. A current trend in designing the magnetic separator towards higher capacities per unit so as to obtain lower capital and operating cost. The other parameters for evaluating magnetic separators is the energy consumption per unit time during operation.

Most of the iron smelting and steel making companies run a number of hot rolling mills. Those rolling processes involve a pickling-oiling line to maintain an excellent surface condition of the milled sheet just before coiling the steel sheets. Suppose the milled sheets containing any type of metal chips, particles and milled scales on their surface are supplied into the pickling cell, then the outcoming sheets always show some types of roll-mark such as dents, stains, scratches, etc. These sorts of defects used to deteriorate the quality of hot rolled sheet, which eventually become a source of economical loss. The goal of present study was to design a high gradient magnetic separator for installing at the place ahead of pickling-oil line to collect any type of metallic fine particles. Therefore, the separator was destined to exhibit a cost-effective roll type high performance magnetic field.

### 2. Design Criteria

#### 2.1 Magnetic field analysis using Opera-2D software

In general, two analytical approaches employed in magnetic field are known to be magnetic vector potential and scalar potential. However, the magnetic scalar potential is frequently used due to its simplicity in numerical analysis. In the Finite Element Method solutions are obtained by creating boundaries according to the characteristics of the media constituting the system concerned, and by transferring the created equations into differential equations. In Opera-2D software the magnetic field analysis starts from creating the boundaries as shown in Fig. 1. The system ( $\Omega$ ) will be divided into two boundaries such as electric conducting region ( $\Omega_1$ ) and non-conducting region ( $\Omega_2$ ).  $\Omega_1$  corresponds to the region where an induced current is produced by electromagnetic force based on the Faraday Law.  $\Omega_2$  is the region where no induced current flows but includes the conductor ( $\Omega_3$ ) from which the current is produced. The region  $\Omega_3$  is, however, defined only for a condition in solving the problems but not involved in the boundary to be analyzed [2]. The beneficial merit of the Opera-2D software is to enable users to select the both magnetic vector potential and/or magnetic scalar potential independently.

#### 2.2 Principle and design concept of magnetic separation

Fig. 2 demonstrates the schematics of magnetic separation of the particles from steel sheet. Suppose the fine particles of metal chips which are adsorbed onto the

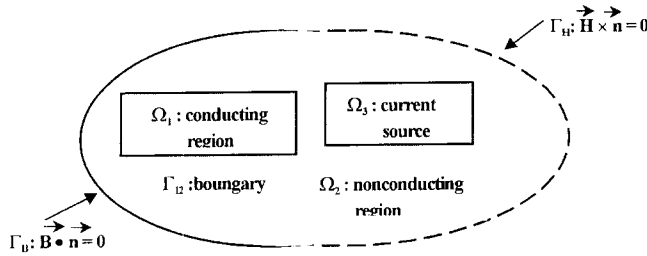

Fig. 1. Simple model configuration for magnetic field.

surface of hot milled steel sheet get into a region of magnetic flux, the particles shall be magnetized and feel an induced magnetic force. Of course the steel sheet shall be magnetized at the same time, and exhibits an attractive force between particle and milled sheet. However, the attractive force becomes negligible once the fine particles get into a strong magnetic field. If the magnetic force induced in a particle is  $F_m$ , the gravity of the particle is  $F_g$  ( $=mg$ ), and the interactive attraction force between and the steel sheet and particle is defined as  $F_p$ , then the critical force required to remove the particle from the surface of steel sheet ( $F_z$ ) along the vertical direction ( $z$ ) can be described as follow [3~5]:

$$F_z = \frac{m \chi}{\mu_0} B_z \frac{dB_z}{dz} - mg - F_p$$

where  $m$  is the mass of particle,  $\chi$  is susceptibility of the particle,  $\mu_0$  is permeability of space, and  $B_z$  is the magnetic flux density produced from the separator along the vertical direction. Therefore, the first term of the right hand side equation is  $F_m$ . In this description the inertia is assumed to be zero because the particles are moving accompanied with the proceeding of steel sheet. According to the above equation the particle can be separated from the steel sheet when the force  $F_z$  becomes positive.

Work scope of the present study is to design an optimized distribution of permanent magnet blocks which are to be radially placed with respect to the drum axis, and along the long axis of the drum as well. To accomplish the goal, the computer simulation was carried out to calculate the strength of the magnetic flux density by varying the number of magnets and position as well. The magnets used were NdFeB magnets having the energy product of 30 MGOe, and the size of the magnet blocks was 2"×2"×1". Fig. 3 shows the schematics of the separator which also illustrate the position with respect to the proceeding steel sheet. Each of the NdFeB magnet block was magnetized along the long periphery (2" side).

Basically the separator roll consists of cylindrical drum core where 6 rows of NdFeB magnet blocks were aligned along the long axis of the drum core. The magnet blocks were inserted into disk holders made of Al 2024 alloy. However, two kinds of Al disks were used. The one has slits into which NdFeB magnet blocks were inserted, and the other has no slit but has the same dimension to the

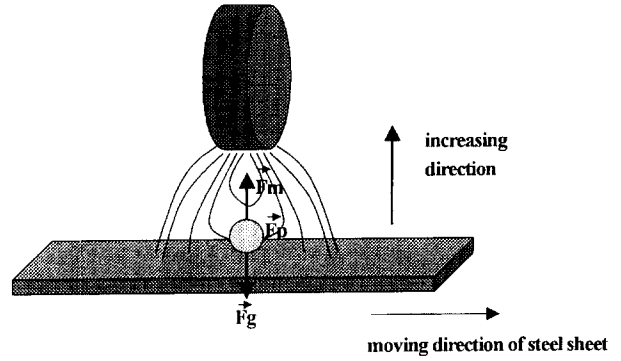

Fig. 2. Schematics of magnetic separation of the particles from steel sheet.

previous disk. Accordingly the magnet blocks are to be placed with a constant interval one another. We calculated the optimal interval by computer simulation. At the same time optimal inter-distance between magnet blocks placed along the circumference direction was simulated. The magnet holders were assembled by fixing disk by disk along the drum axis. Finally outer shell made of stainless steel case was covered which is rotating around the fixed drum core with respect to the same axis. Incidental mechanical parts such as driving motors for rotating the outer shell, hydraulic system for controlling the position of whole separator set were installed.

### 3. Computer Simulation

#### 3.1 Modeling of the magnetic roll

According to the basic concept shown in Fig. 3 taking into account the symmetrical shape and identical dimension of each magnet, two dimensional model of the magnet holder's cross section was drawn as shown in Fig. 4. Out diameter of the drum case was 15.9 cm, inner diameter was 15.7 cm. The magnet holder having a diameter of 14.8 cm into which the NdFeB magnet blocks of 6 rows were imbedded is shown in the figure. In this model, the magnetic field distribution along the axial direction is assumed to be invariant and the vector component along that direction is assumed to be none in order to make the model to be xy-symmetrical. All the structural materials constituting the separator except the NdFeB magnets were non-magnetic ( $\mu=1$ ). In operating the Opera-2D program the magnetic properties of NdFeB magnets used in this study were measured, and adopted as the input data. As shown in Fig. 5, the magnets exhibited a remanence value(Br) of 13.17 kG and intrinsic coercivity value ( $iHc$ ) of 14.3 kOe. Data obtained from the demagnetization curve were normalized and converted into the Opera-2D formation. Fig. 6 shows the model meshed by linear element method.

#### 3.2 Numerical solution for magnetic flux distribution and field strength

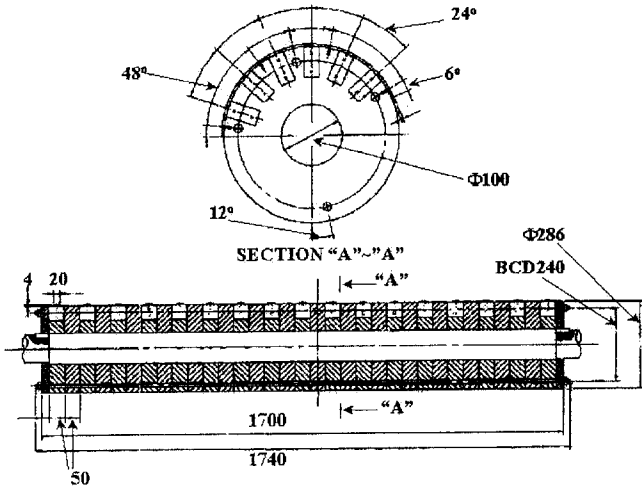

Fig. 3. Basic concept of magnetic separator.

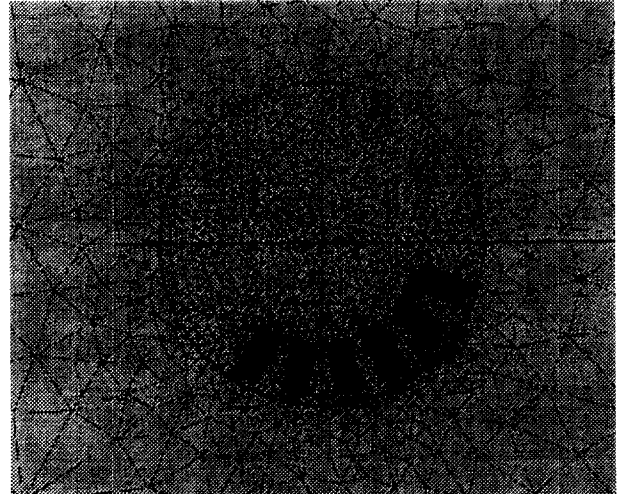

Fig. 6. A model meshed with triangular element.

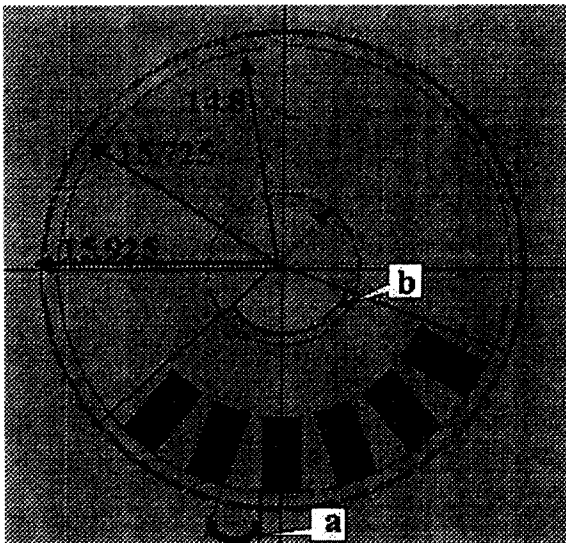

Fig. 4. An OPERA-2d model of magnetic separator.

In running the Opera-2D software, the numerical analysis was performed by using "Static Field" program on the assumption that all the materials exhibit linear properties. This process enables users to save the operating procedures. After obtaining solutions the data again was

converted into "Pre and Post Processor" program, and the magnetic flux density was able to be plotted. This process gave the flux density distributions plotted according to their field strength. In our study, the flux density values from 0.733 to 13541 Gauss were able to be resolutionized. Fig. 7 shows the typical distribution of magnetic flux density induced when the interval between the NdFeB magnets was 24° being measured from center to center of the magnets. The arrows indicate the vector directions and magnitudes as well. By varying the intervals ("a" values in Fig. 4) and the limit of the field source ("b" values in Fig. 4), an optimized model was simulated.



Fig. 7. Magnetic flux density distribution and strength.

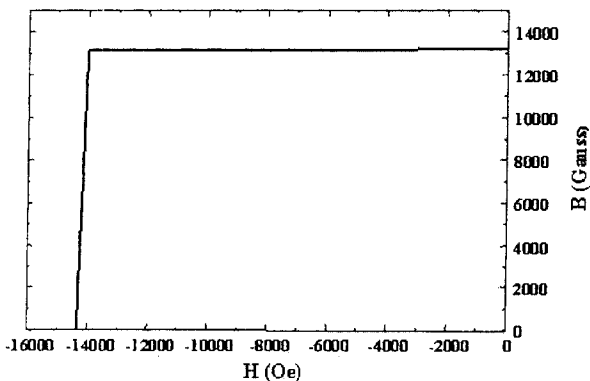

Fig. 5. Demagnetization curve of Nd<sub>2</sub>Fe<sub>14</sub>B magnet.

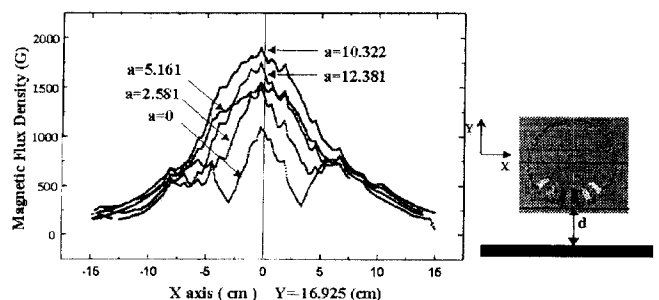

Fig. 8. Variation of magnetic flux density at  $d=1$  corresponding to the interval between the NdFeB magnets.

Some typical results obtained by mapping the numerical solutions into magnetic flux density distributions are plotted in Fig. 8. This plot shows the case when the distance between the magnet roll and steel sheet is 1 cm away. Each curve indicates the variation of magnetic flux density corresponding to the interval between the NdFeB magnet. As shown in the figure, the strongest magnetic flux density and wide range of distribution were obtained when the "a" was 12.4°. The highest magnetic flux density from the outer surface of the separator drum can be seen to be almost 2000 Gauss at the steel sheet even though the distance is 1 cm away each other. The field distribution shows an exact symmetry.

In order to determine the magnetic region, i.e., working region where an effective separation of the particles takes place, we needed to determine the position of the magnets with respect to the position of proceeding steel sheet. Therefore another simulation was carried out by rotating the magnetic field area with respect to the point of contact at the steel sheet. Fig. 9 shows the results of simulations. The simulation was performed with a condition that 0° rotating means the position when 6 magnets are divided into two symmetrical region with respect to the point of contact. The plot indicates the range of flux distribution up to ±15 cm away from the point of contact. Taking into account the field strength and range of the distribution, we selected the rotating range of 20° as the optimal position due to its wide range of uniform distribution at the region of point of contact. These simulations were carried out with varying the working distance between the separator and steel sheet from 1 to 3 cm. Fig. 9 corresponds to the case when the distance is 1 cm. It is confirmed that the area of 12 cm width at the steel sheet along the long axis of the separator drum has the field strength higher than 700 Gauss.

#### 4. Comparing the Simulated Model with Measured Data

Before assembling the magnetic separator on the basis of simulated model, a prototype separator drum was assembled, and its magnetic flux density distribution and strength

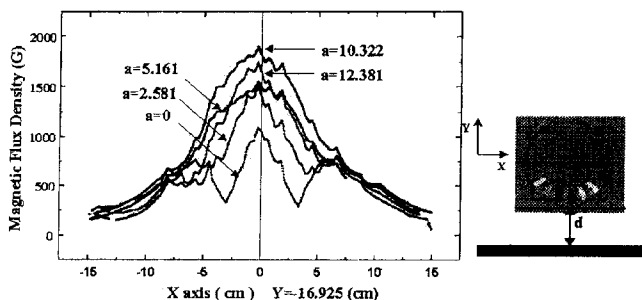

Fig. 9. Variation of magnetic flux density at d=1 corresponding to rotating magnetic separator with respect to the point of contact at the steel sheet.

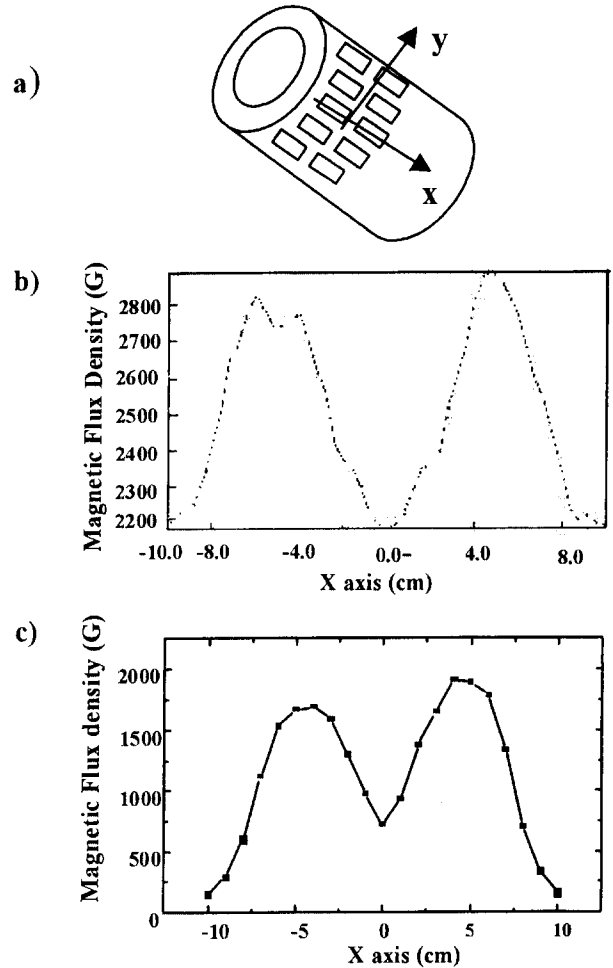

Fig. 10. The result of computer simulation and measured data on the surface of steel sheet.

were certified. Fig. 10(a) shows the schematic view of the position from which the data were measured. X denotes the longitudinal axis of the separator drum and Y is for circumferential direction, respectively. All the measurements were made on the steel sheet placed 1 cm below from the point of contact of drum surface considering the real situation of hot rolling mill. Fig. 10(b) and 10(c), which are the plots measured along the X direction of the Fig. 10(a), show the result of computer simulation and measured data on the surface of steel sheet, respectively. The plots indicate that the distribution of magnetic flux density is almost identical. However, the magnetic strength of the measured data reaches 70% of those of simulated result. This is due to the assumption made in numerical analysis. During the simulation, the magnetic properties of NdFeB magnets were regarded as a linear characteristic, and permeability of the magnets was applied as a constant. In fact this assumption is not correct. At the same time, the magnetic flux leaked from interaction between the magnet blocks was neglected during the simulation, which is not real either.

In conclusion, a new type of magnetic separator was designed and installed at Pohang Iron & Steel Co. for

removing fine particles from hot milling steel sheet. NdFeB rare earth magnets of  $(B \cdot H)_{max} = 30$  MGOe were used. The yield of separation was more than 95% for the particles coarser than  $38 \mu\text{m}$ , and the yield tends to decrease for the particles finer than  $38 \mu\text{m}$ .

### References

[1] J. Svoboda, Magnetic Methods for the Treatment of Minerals, El-

sevier, New York(1987), pp.121.

[2] Introduction to computational electromagnetics, Vector Field Ltd., (1995), pp.7.

[3] J. Tadeusz and K. Slawomir, IEEE Trans. Magn., **29**, 3261(1993).

[4] T. Janowski and S. Kozak, IEEE Trans. Magn., **26**, 1864(1990).

[5] J. Gerald, IEE Trans. Magn., **28**, 655(1992).